

**Siemens, Model # SUAS877-PG**  
(or **Landis & Gyr # UAS877-PG**)



**Eaton-Durham**  
Model # UTRS223ACH



**Midwest**  
UTRS223AMEP

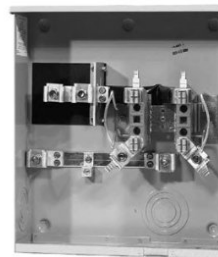

**Milbank**  
Model # U1980-O

These are some examples of the single meter sockets we require for underground service. Our cable comes in on the bottom and goes straight into the terminal lugs. No Wire Bending Required.

Socket/Breaker combination panels with this design are also acceptable and shown on our web-page under "Meters".

Effective June, 2008

Revised April, 2013

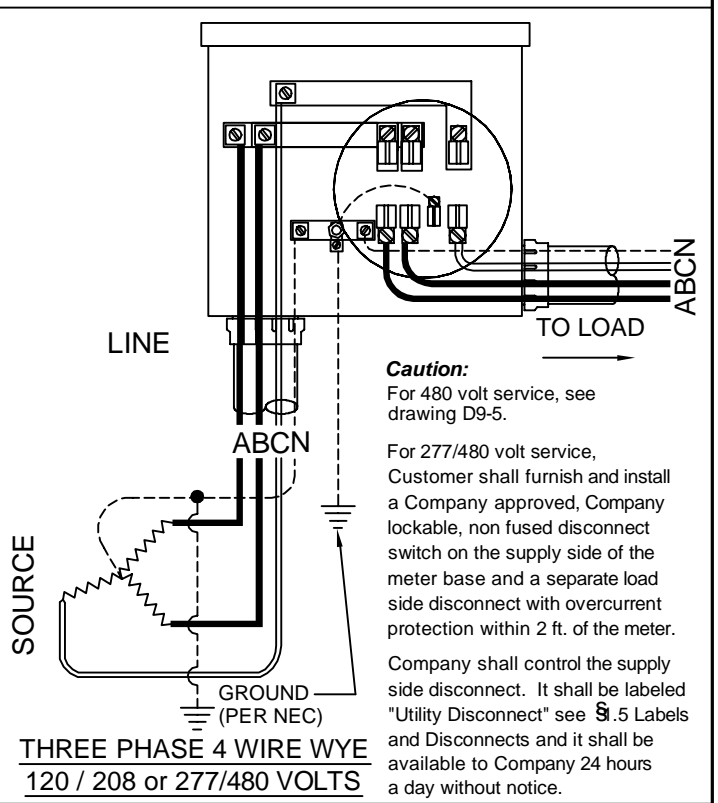
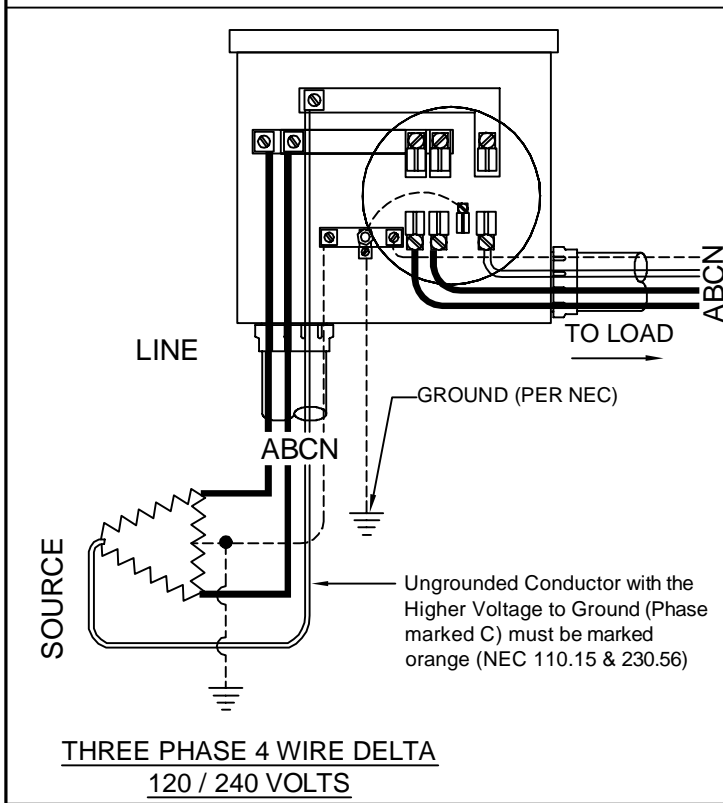
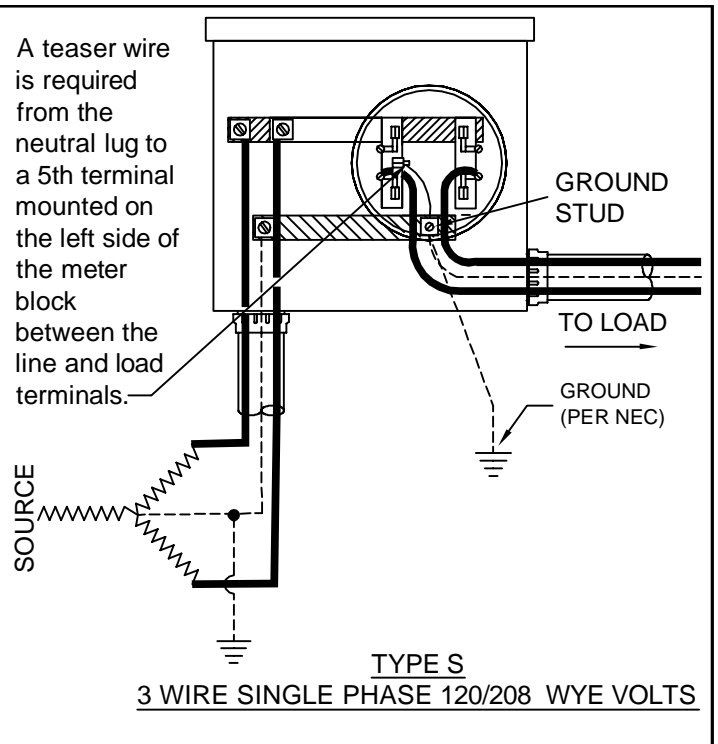
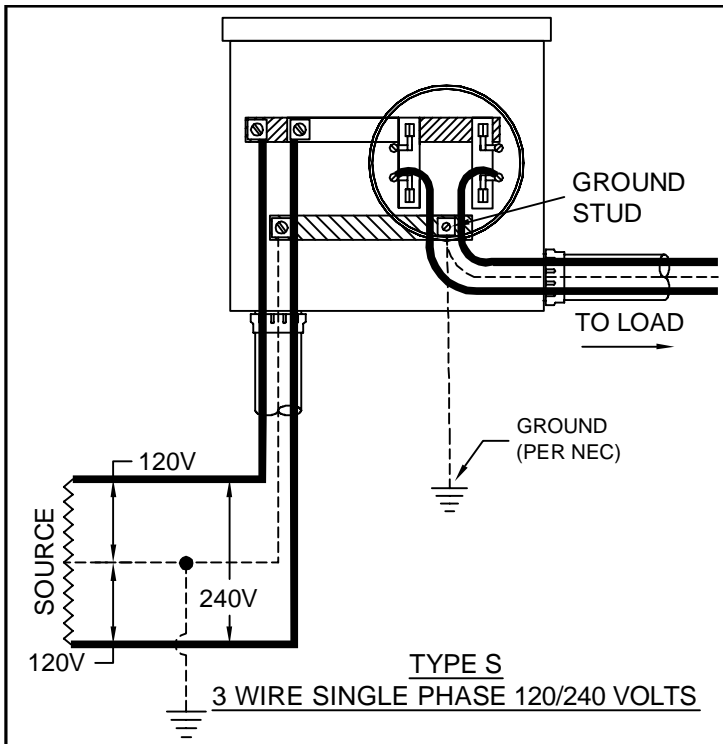

**Notes:**

1. All diagrams on this drawing show connections when the switch is installed on the right side (see Right Side below) of the meter socket. If the switch is installed on the left side of the meter socket you will need to mirror this diagram (see Left Side below).
2. All sockets, except residential single phase less than 320 Amps, shall have a manual mechanical gang operated bypass switch.
3. Load and supply wires shall not cross in the meter socket.

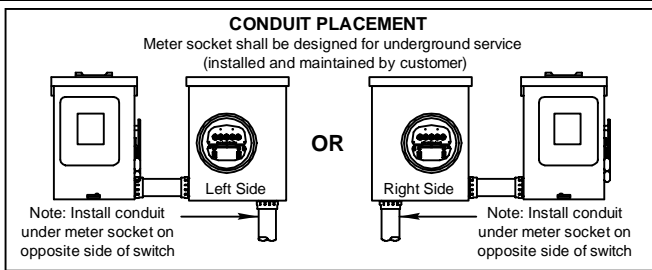

**ENTERGY SERVICES, INC.**  
**WIRING DIAGRAM CONNECTIONS**  
**FOR UNDERGROUND**  
**SELF CONTAINED METERS**

APPROVED BY: JRH	DATE: 01/10/2013
CHECKED BY: JED	SCALE: NONE
DRAWN BY: krich95	

1	01/13	REVISION OF DRAWING SS11.8-2	EJH	
NO.	DATE:	REVISION	BY:	APPR:

**No. D9-3**

PLOT	1=1	SH. 2 OF 2
------	-----	------------

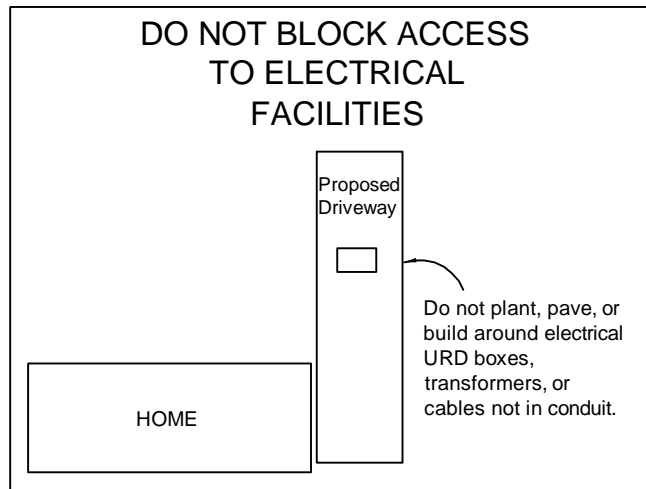
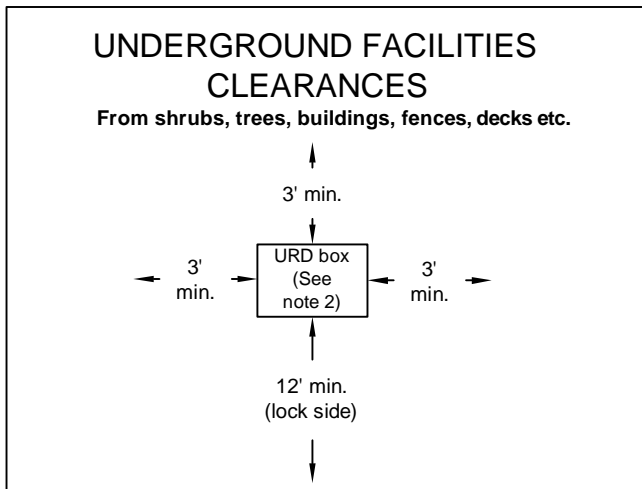
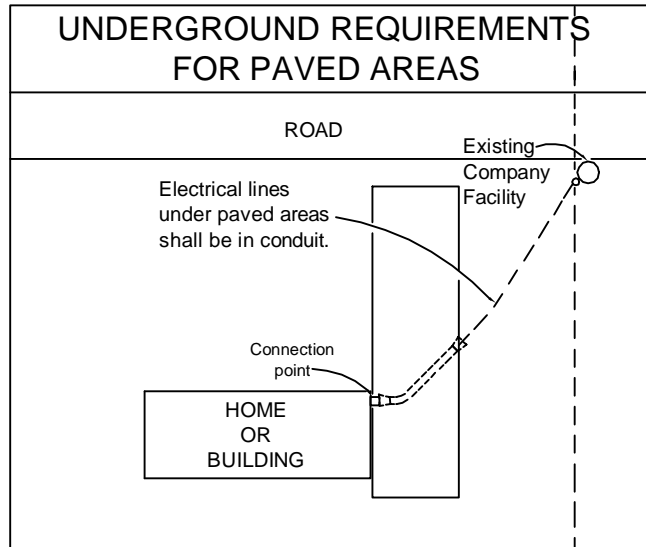
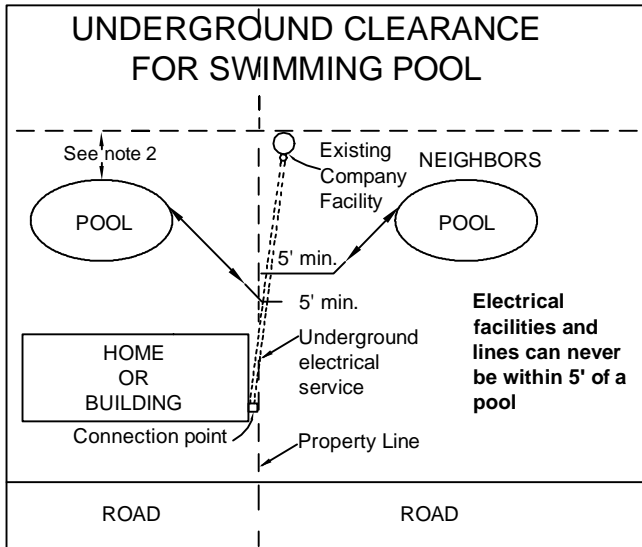

**SERVICE CABLE IS NOT ALLOWED BELOW A BUILDING.**

Minimum Customer Wiring Size - Residence Single Phase **				
METER SIZE	CONDUIT SIZE	Current carrying & neutral wire size (per NEC)		GROUND WIRE SIZE
		COPPER	ALUMINUM	
100 Amp	2"	#4	#2	#6
200 Amp	2.5" *	2/0	4/0	#4
320 Amp	3"	350	500	#2

\* Arkansas locations only allows 2"

\*\* For 3Ø, consult the Company, Commercial/Industrial wire sizes are typically larger.

### CALL 811 TWO BUSINESS DAYS BEFORE YOU DIG

In locations with underground facilities, the Customer shall notify One Call and shall have One Call locate all underground facilities before digging. It shall be the responsibility of the Customer to stay clear of all underground facilities.

**Notes:**

- The Customer is responsible for clearing and maintaining all right of way.
- NEVER** build anything under or over existing electrical lines or facilities. Check with the Company for clearances.
- Contact Company for clearances prior to pool construction.**
- Connection point shall be pre-approved by the Company.
- Transformers must meet requirements of drawing D10-1.
- The Customer shall bear the cost of conduit and its installation.
- Underground service/conduit should be installed separated by not less 24" of well tamped earth from other utilities.
- Conduit color shall be electrical gray or black with red stripes (for continuous below ground conduit). Conduits above the ground and transition elbow or conduit from underground to above ground, shall be schedule 80 PVC or equivalent. Generally, non-metallic conduit installed totally below grade shall be at least Schedule 40 PVC or equivalent. In certain cases, concrete encasement may be required according to Drawings D8-2 and D8-7. All conduits, elbows, fittings, etc. shall be UL approved with an U. L. label.

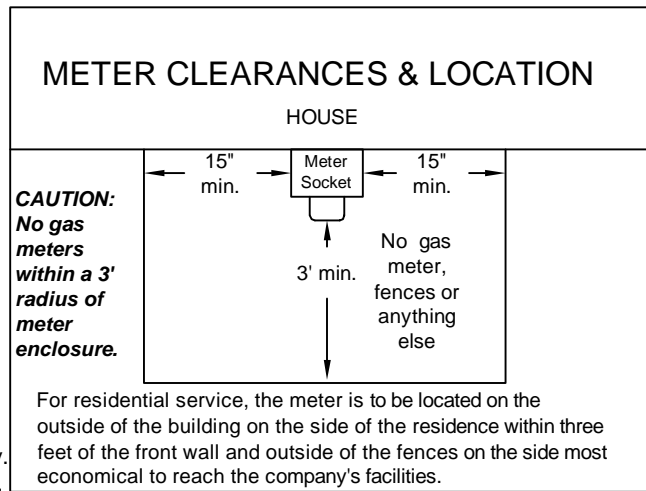

<b>ENTERGY SERVICES, INC.</b>			
<b>UNDERGROUND SERVICE INSTALLATION DETAILS &amp; CLEARANCES</b>			
APPROVED BY:	JRH	DATE:	10/24/2012
CHECKED BY:	JED	SCALE:	None
DRAWN BY:	krich95		
		No.	D8-1
NO.	DATE:	REVISION	BY: APPR:
		REVISION	
		PLOT	1=1
		SH.	1 OF 1

1	10/12	REVISION OF DRAWING SS8.6.6.	JED	
NO.	DATE:	REVISION	BY:	APPR:

**CONDUIT PLACEMENT**

Meter socket shall be designed for underground service installed and maintained by Customer. Main breaker should be within 2'-0" of the meter. Outside wall recommended.

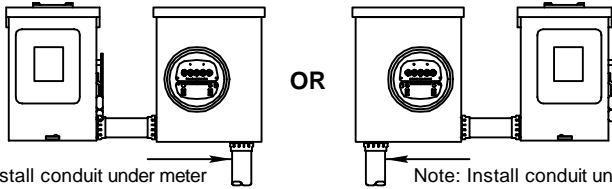

Note: Install conduit under meter socket on opposite side of switch

Note: Install conduit under meter socket on opposite side of switch

**Shall meet requirements of drawings D8-1, D8-2 and D9-3.**

**SEE DRAWING D9-3 WIRING DIAGRAM CONNECTIONS FOR UNDERGROUND SELF CONTAINED METERS**

**CALL 811 TWO BUSINESS DAYS BEFORE YOU DIG**

In locations with underground facilities, the Customer shall notify One Call and shall have One Call locate all underground facilities before digging. It shall be the responsibility of the Customer to stay clear of all underground facilities.

**NOTES:**

1. Customer facilities shall comply with Company Standards, the National Electrical Code, and authorities having jurisdiction.
2. Meter socket shall be installed and maintained by the customer.
3. The customer shall install 80lb test non-metallic (manila or grass) pull line in the conduit. Conductor normally supplied by Company.
4. Bends and turns in the conduit to fit the contour of the wall or slab are not permitted. Cable binding may occur in bent conduit, causing failures. Any turns or bends shall have a minimum radius of 3'-0".
5. Spacing material, such as treated wood or metal, to be rigidly and securely attached to structure at a sufficient thickness to keep the conduit to the meter free of bends.
6. Concrete encasing on elbow is required where soil subsidence is possible, consult with Company.
7. Conduit color shall be electrical gray or black with red stripes (for continuous below ground conduit). Conduits above the ground and transition elbow or conduit from underground to above ground, shall be schedule 80 PVC or equivalent. Generally, non-metallic conduit installed totally below grade shall be at least Schedule 40 PVC or equivalent. In certain cases, concrete encasement may be required according to Drawings D8-2 and D8-7. All conduits, elbows, fittings, etc. shall be UL approved with an U. L. label.
8. Conduit shall be flush with wall. The foundation may be required to have blocked out area for conduit in order for conduit to be flush with wall when installed. Conduit is not allowed behind the wall.
9. Upper end of ground rod to be flush with or below grade.
10. Conduit required in restricted access or paved areas. (See section 8.10)
11. Main breaker should be within 2'-0" of the meter. Outside wall recommended.
12. Consult a Company Representative for required system in your area.

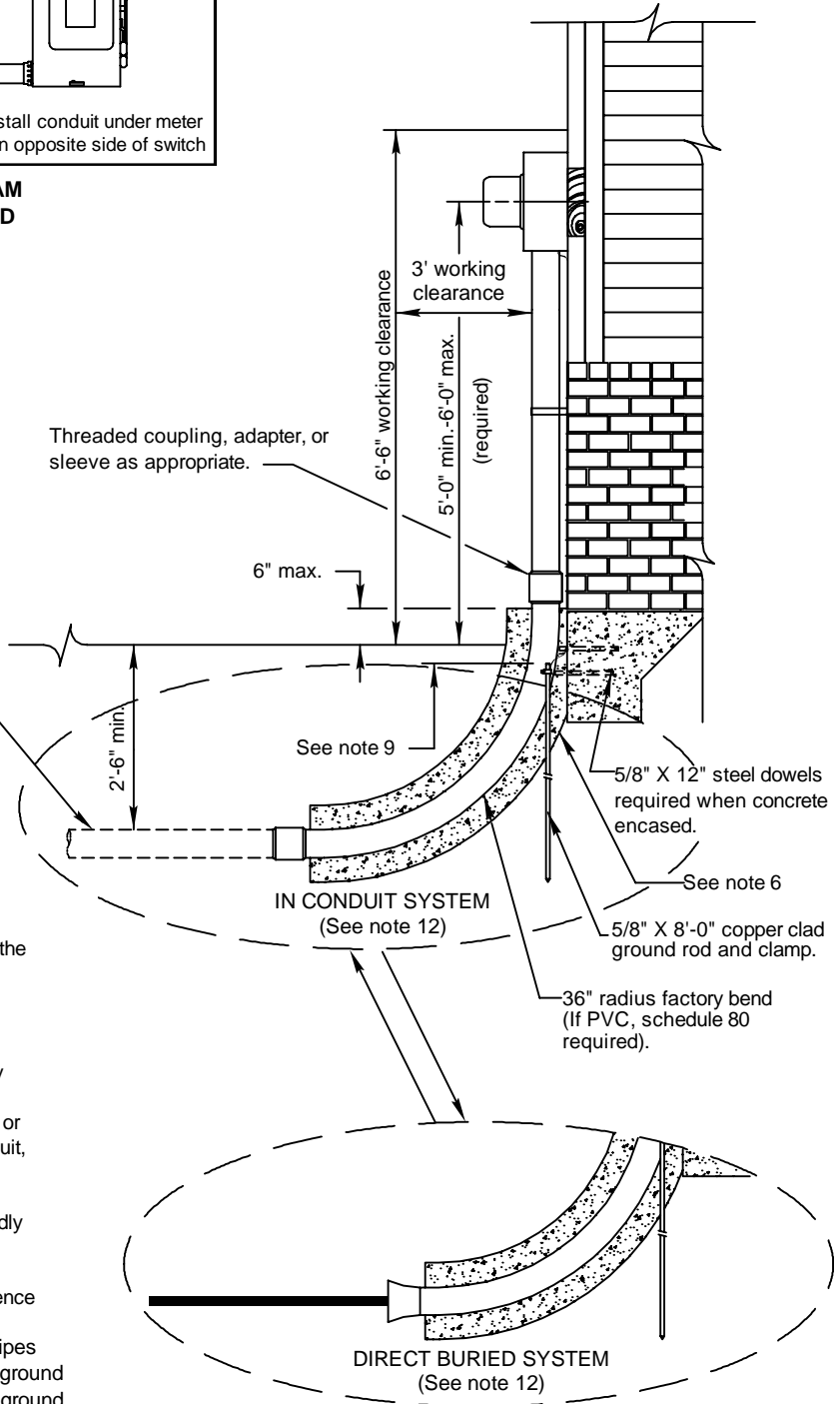

**ENTERGY SERVICES, INC.**

**DETAILS FOR TYPICAL UNDERGROUND SERVICE AT HOUSE OR BUILDING**

APPROVED BY: JRH	DATE: 11/06/2012
CHECKED BY: JED	SCALE: NONE
DRAWN BY: krich95	

No. **D8-3**

PLOT 1=1 SH. 1 OF 1



1	10/12	REVISION OF DRAWING SS8.6-4	JED	
NO.	DATE:	REVISION	BY:	APPR:

Shall meet requirements of drawing D10-1.

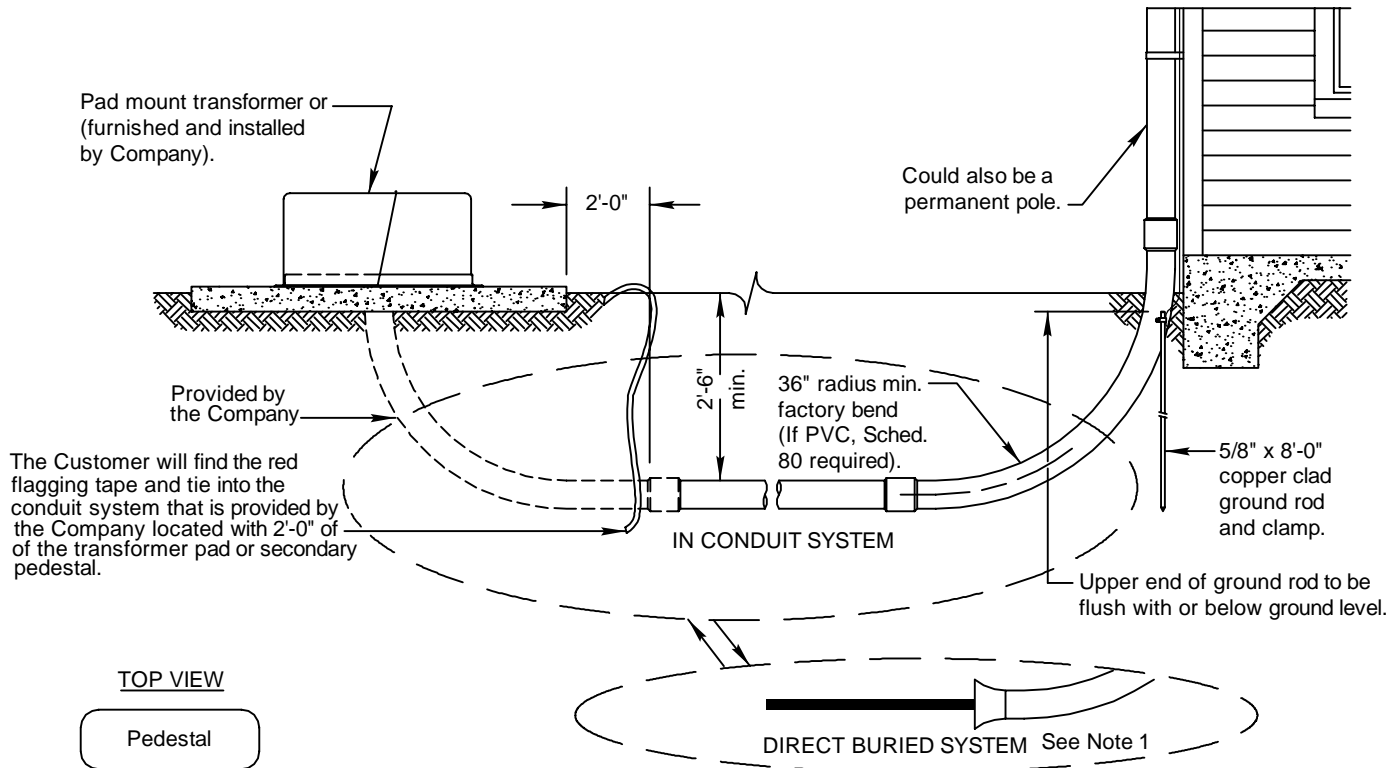

TOP VIEW



Street Side

Bring cable or conduit to one foot from the center of the pedestal buried at 30" below the ground.

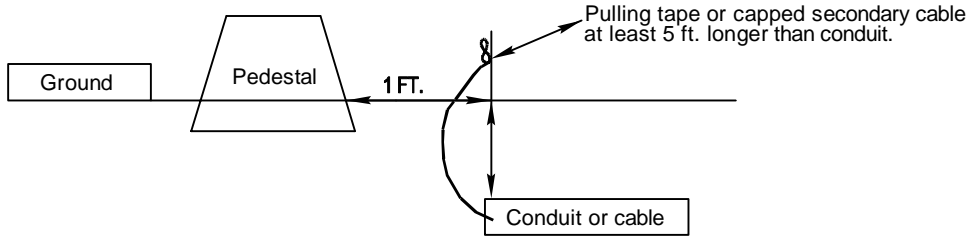

For direct buried, cable must be long enough to reach the connectors in the pedestal (at least 5 extra feet).

For Customer installed and supplied conduit, pulling tape must be long enough to reach pedestal (at least 5 extra feet) and the elbow to enter the pedestal is supplied by the Customer and installed by the Company.

**CALL 811 TWO BUSINESS DAYS BEFORE YOU DIG**

In locations with underground facilities, the Customer shall notify One Call and shall have One Call locate all underground facilities before digging. It shall be the responsibility of the Customer to stay clear of all underground facilities.

<b>ENTERGY SERVICES, INC.</b>	
<b>PADMOUNT TRANSFORMER OR SECONDARY PEDESTAL SERVING A CUSTOMER</b>	
APPROVED BY: <b>JRH</b>	DATE: <b>11/06/2012</b>
CHECKED BY: <b>JED</b>	SCALE: <b>3/8"=1'-0"</b>
DRAWN BY: <b>krich95</b>	

Notes:  
1. Contact Company for local area requirements.

1	10/12	REVISION OF DRAWING SS8.6-2	JED	
NO.	DATE:	REVISION	BY:	APPR:



<b>No. D8-4</b>	
PLOT	1=1 SH. 1 OF 1

**TYPICAL PULL BOX PEDESTAL**

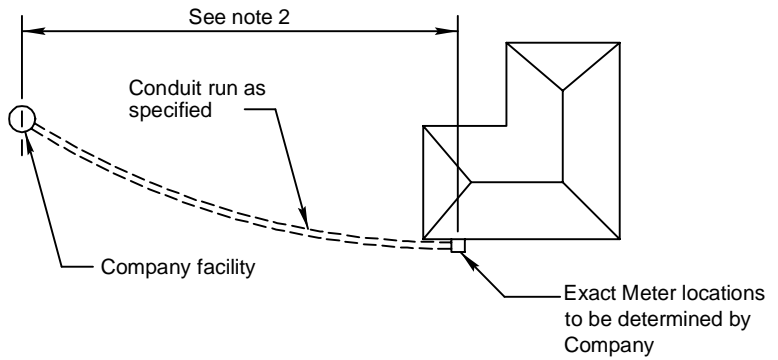
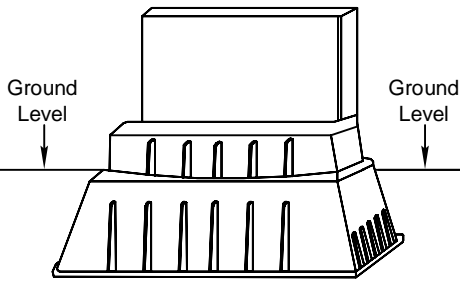

**STANDARD SERVICE INSTALLATION**

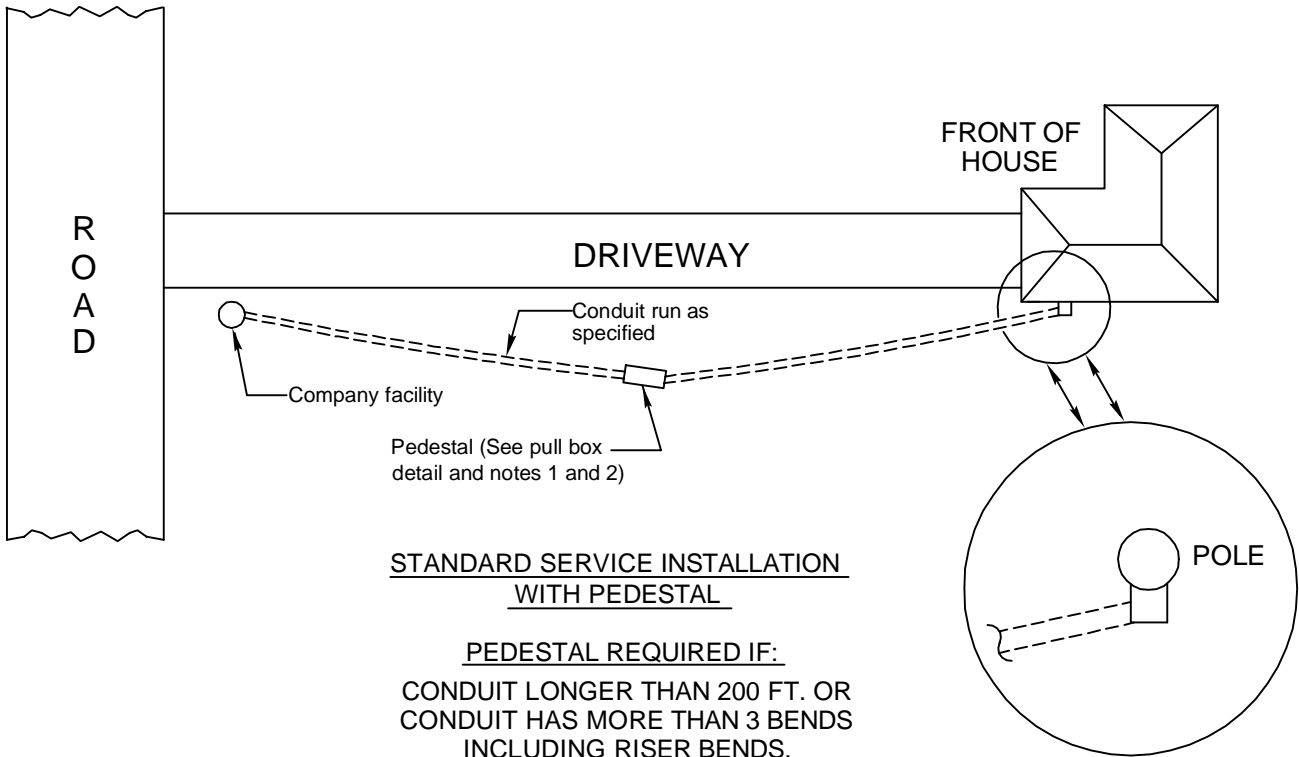

**CALL 811 TWO BUSINESS DAYS BEFORE YOU DIG**

In locations with underground facilities, the Customer shall notify One Call and shall have One Call locate all underground facilities before digging. It shall be the responsibility of the Customer to stay clear of all underground facilities.

**Notes:**

1. Customer shall consult with Company for location and type of pedestal.
2. The Customer shall bear the cost of conduit and its installation.

**ENTERGY SERVICES, INC.**

**TYPICAL CONDUIT SYSTEM REQUIREMENTS FOR SECONDARY PHASE CUSTOMER UNDERGROUND SERVICE**

APPROVED BY: JRH	DATE: 10/31/2012
CHECKED BY: JED	SCALE: NONE
DRAWN BY: krich95	

No. D8-2

1	10/12	REVISION OF DRAWING SS8.6-1	JED	
NO.	DATE:	REVISION	BY:	APPR:



PLOT 1=1 SH. 1 OF 1

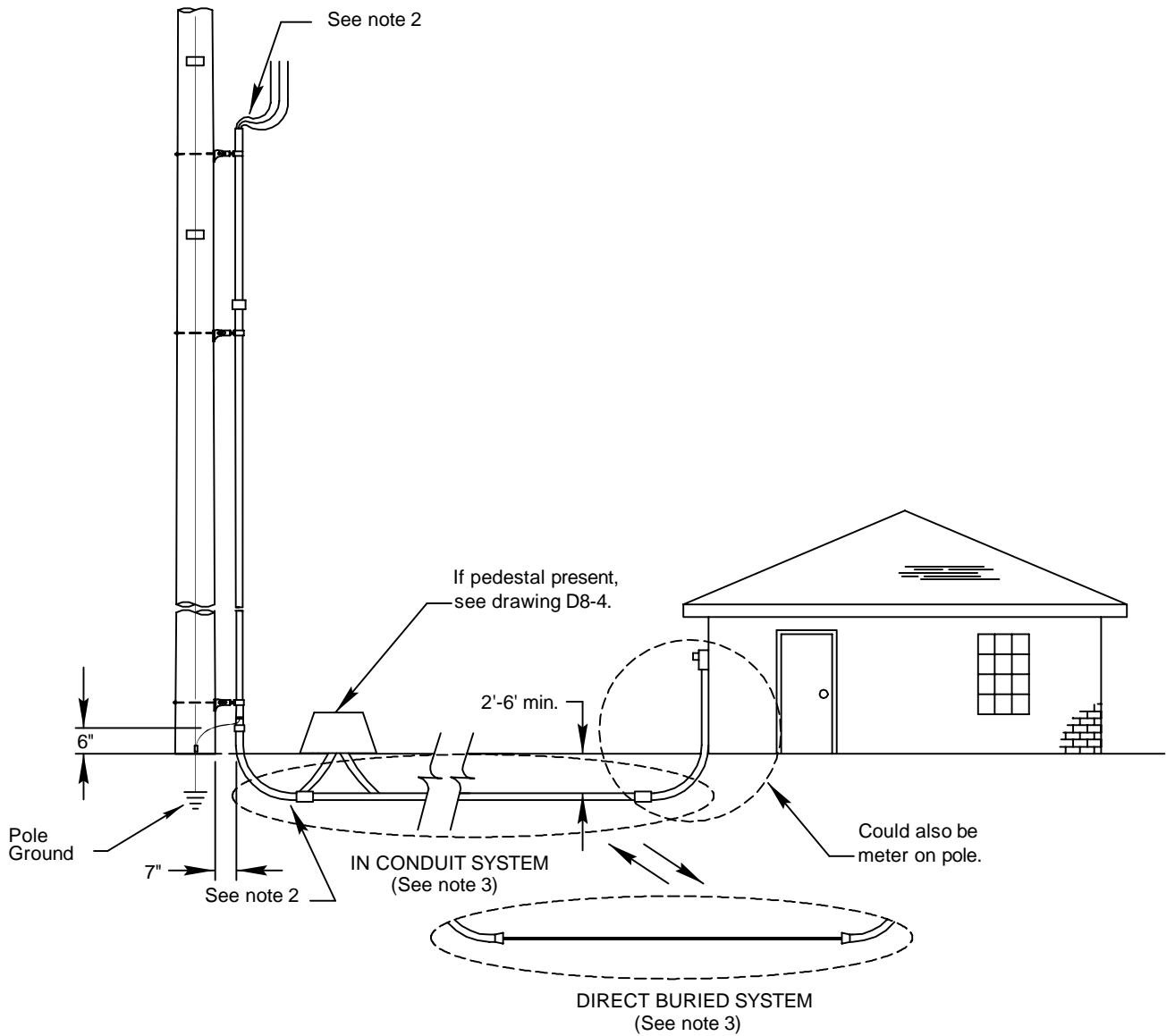

**Notes:**

1. If one conduit installation is already on the pole, Contact the Company to (at its option) install a pedestal at the base of the pole.
2. Customer shall install the conduit to 7" from the pole. The Company will install the Customer supplied riser material up the pole. The Customer shall supply enough conduit to extend up the pole to a point 50" above the Telephone Co.'s and/or cable. When these minimum conditions cannot be satisfied, the Customer shall consult the Company. The Customer shall secure the riser material at the meter entrance for installation by the Company. **(EXCEPTION: In Arkansas and Mississippi the conduit for the riser is supplied by the Company)**
3. Contact Company for local area requirements.

**CALL 811 TWO BUSINESS DAYS BEFORE YOU DIG**

In locations with underground facilities, the Customer shall notify One Call and shall have One Call locate all underground facilities before digging. It shall be the responsibility of the Customer to stay clear of all underground facilities.

**ENTERGY SERVICES, INC.**

**TYPICAL UNDERGROUND SERVICE FROM OVERHEAD SOURCE**

APPROVED BY: JRH	DATE: 11/06/2012
CHECKED BY: JED	SCALE: NONE
DRAWN BY: krich95	

**No. D8-5**

1	10/12	REVISION OF DRAWING SS8.6-3	JED	
NO.	DATE:	REVISION	BY:	APPR:



**PLOT 1=1 SH. 1 OF 1**

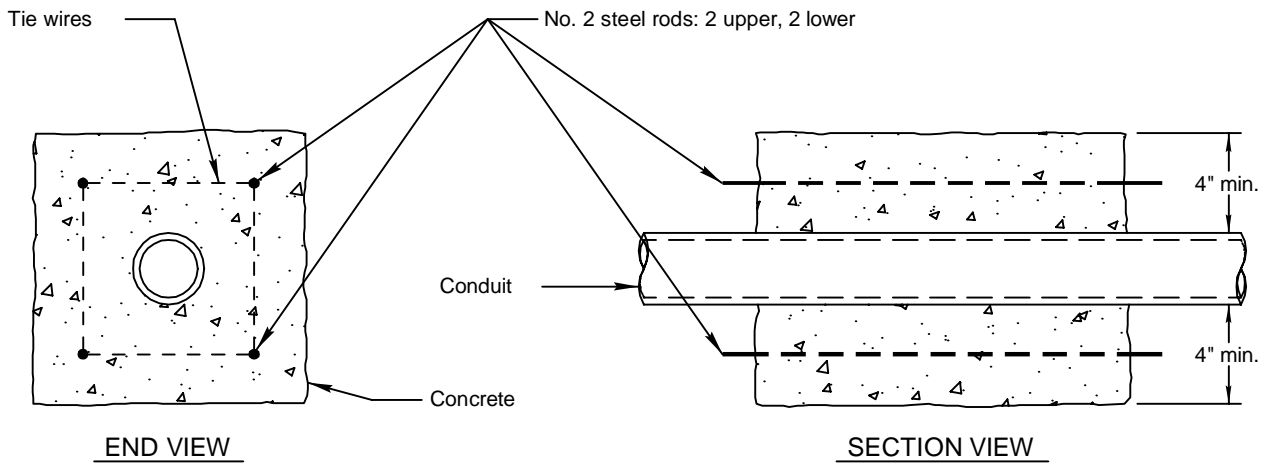
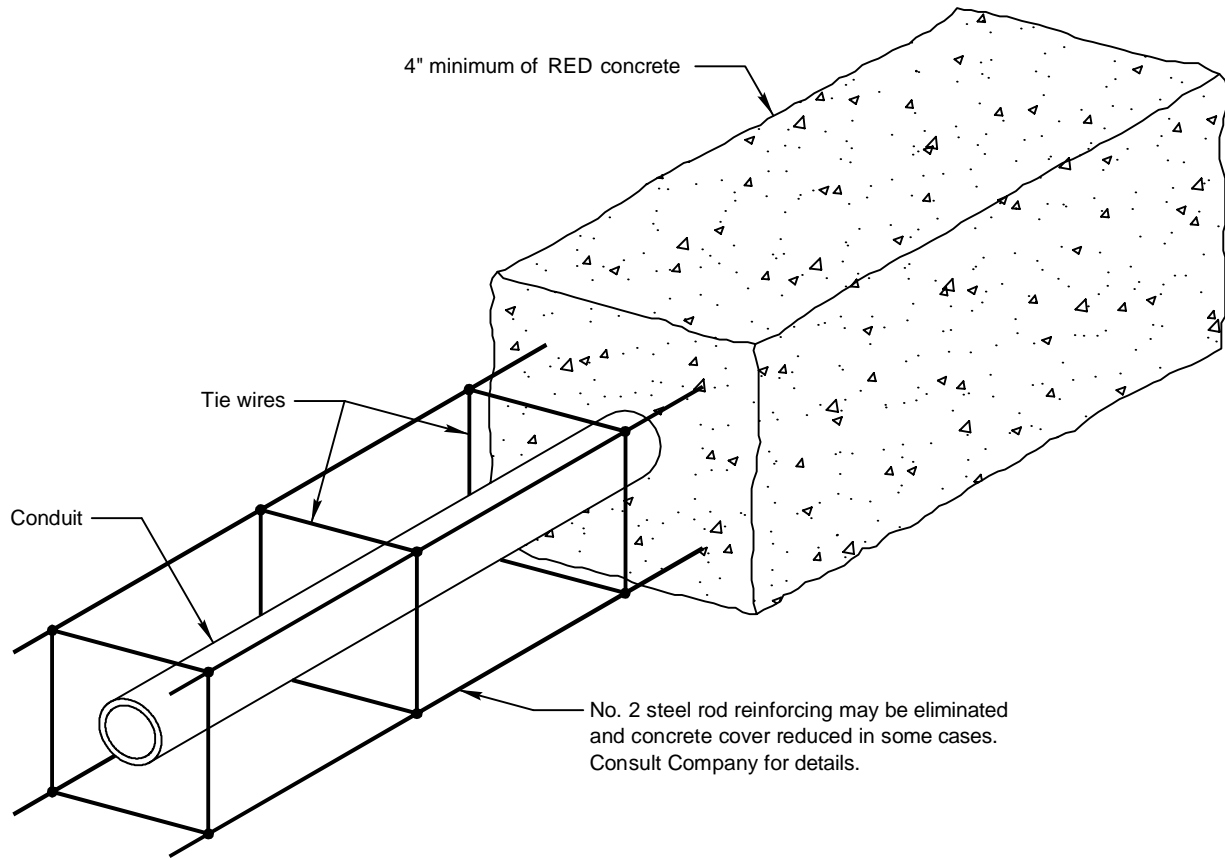

**CALL 811 TWO BUSINESS DAYS BEFORE YOU DIG**

In locations with underground facilities, the Customer shall notify One Call and shall have One Call locate all underground facilities before digging. It shall be the responsibility of the Customer to stay clear of all underground facilities.

ENTERGY SERVICES, INC.

**TYPICAL DETAIL OF METAL CONDUIT ENCASED IN CONCRETE**

APPROVED BY: JRH	DATE: 01/10/2013
CHECKED BY: JED	SCALE: 1 1/2"=1'-0"
DRAWN BY: krich95	



No. D8-7

1	01/13	REVISION OF DRAWING SS8.6-5	JED	
NO.	DATE:	REVISION	BY:	APPR:

PLOT 1=1 SH. 1 OF 1